

ALLEGRI

BY KALCO LIGHTING

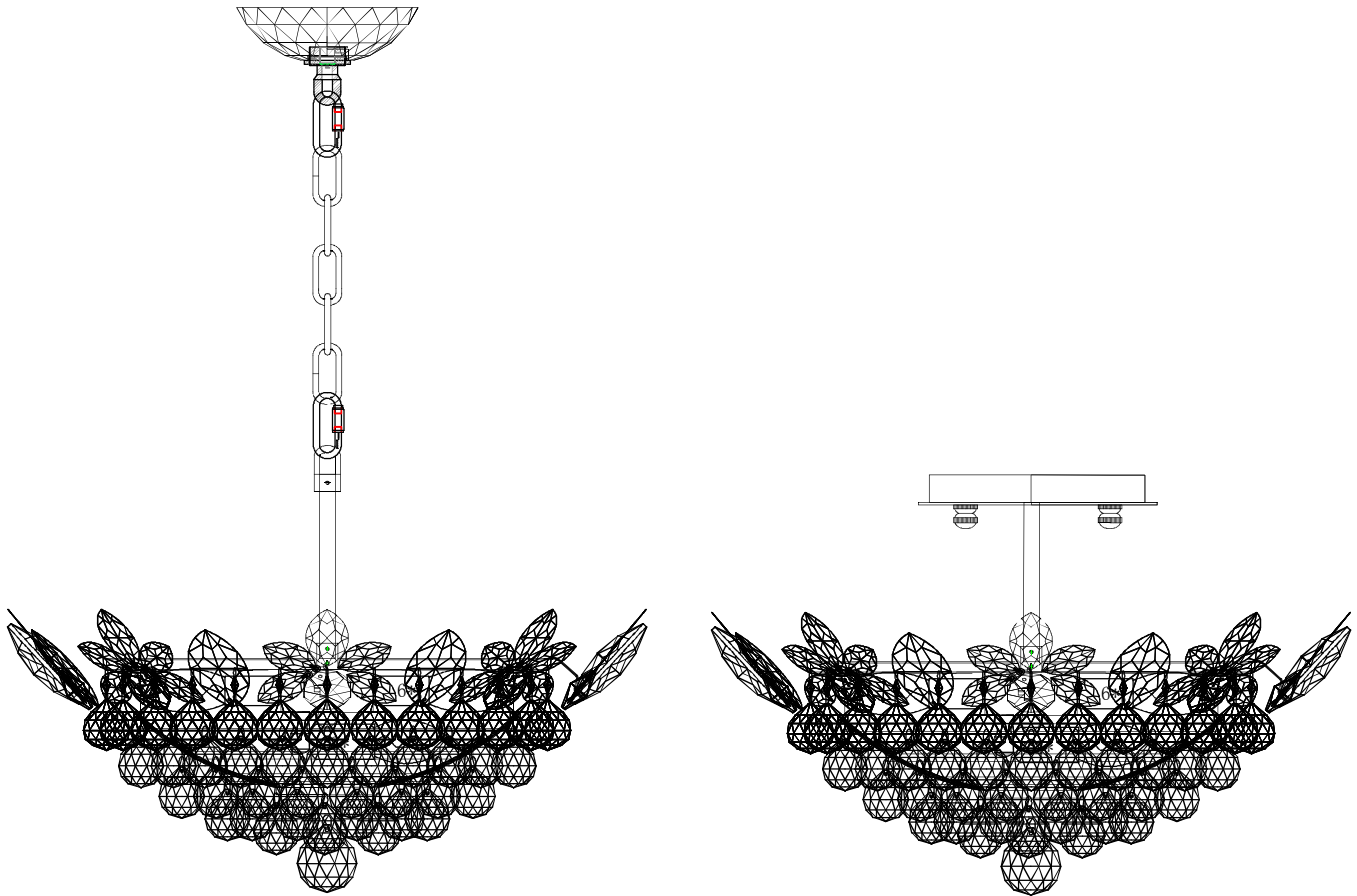

MODEL 021040

ASSEMBLY AND DRESSING INSTRUCTIONS

Blending innovative design, cutting-edge technology and the grace and elegance of traditional crystal, ALLEGRI® proudly brings you a new approach to lighting. ALLEGRI® fixtures are made from the finest raw materials and are brought to life through a combination of traditional manufacturing, such as sand casting, hand-forging and technology driven techniques including laser cutting.

Enclosed are detailed instructions on how to properly install your fixture. Please read all instructions carefully. If you need further assistance, please contact the dealer from which you purchased this product or call 866-820-2665 to speak with an ALLEGRI® customer service representative. We hope you enjoy your fixture!

ALLEGRI



BY KALCO LIGHTING

ASSEMBLY AND DRESSING INSTRUCTIONS

WARNING! **CONTENTS ARE FRAGILE** **HANDLE WITH CARE**

THE METAL FRAME, FINISH AND CRYSTAL COMPONENTS OF THIS CHANDELIER ARE VERY DELICATE.
PLEASE EXERCISE EXTREME CAUTION DURING UNPACKING AND INSTALLATION.

PLACE ALL PIECES TOGETHER IN A NUMERICAL ORDER AND IN THE ORIENTATION DEPICTED.
REFER TO THE PARTS LIST TO AVOID ANY CONFUSION BETWEEN PARTS THE PARTS NUMBER MUST COINCIDE.

CAUTION: FAILURE TO INSTALL THIS FIXTURE PROPERLY MAY RESULT IN SERIOUS PERSONAL INJURY AND PROPERTY DAMAGE. All electrical components must be installed only by a Licensed Electrician. This product must be installed in accordance with the National Electric Code (NEC), and appropriate local electrical code(s), by a person familiar with the construction and operation of the product and the hazard involved.*

CAUTION: Do not exceed maximum wattage note on fixture. Uses only recommended bulbs with fixture.

GENERAL NOTES

- ❖ For your safety and proper operation of fixture, read and understand all instructions completely before commencing installation.
- ❖ This fixture is suited for dry locations. Never install fixture on damp ceiling; room should be dry and well ventilated.
- ❖ Extreme care should be taken to avoid damage to the surface of lighting fixture and wires. Wearing gloves is recommended for installation.
- ❖ Connect ribbed wire of lighting fixture to live wire, while smooth wire of lighting to neutral. Connect bare copper or silver color ground wire of fixture to the double colored or green wire of outlet box.
- ❖ Use UL LISTED wire nuts for the wiring connections in this fixture. Wrap wire nut connections with UL LISTED electrical tape.
- ❖ Keep lighting away from acid, alkali and other corrosive chemical or gas; clean the fixture with a clean cloth only.
- ❖ Fixture must be firmly secured when installing ceiling tube, chain pipe and other connecting parts.
- ❖ Never cover the lighting fixture when power is connected.
- ❖ Disconnect the power before installing, cleaning and/or replacing light bulb.
- ❖ Extreme care should be taken when installing and cleaning of Glass and/or Crystal Components.
- ❖ This product is rated 110-130V/60HZ bulb 40W Maximum.
- ❖ Save these instructions for future reference.

WARNING

The electricity must be turned off at the main fuse box or circuit breaker before installing this fixture. Turning the power off using the light switch may not be sufficient to prevent electrical shock.

*ALLEGRI will not be liable for injury or damage caused by improper installation, lamping or use of this fixture.

ALLEGRI

BY KALCO LIGHTING

Canopy installation option 1 (Pendant)

Option 2 (Semiflush).

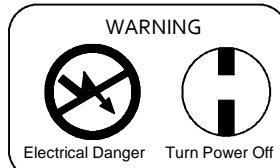
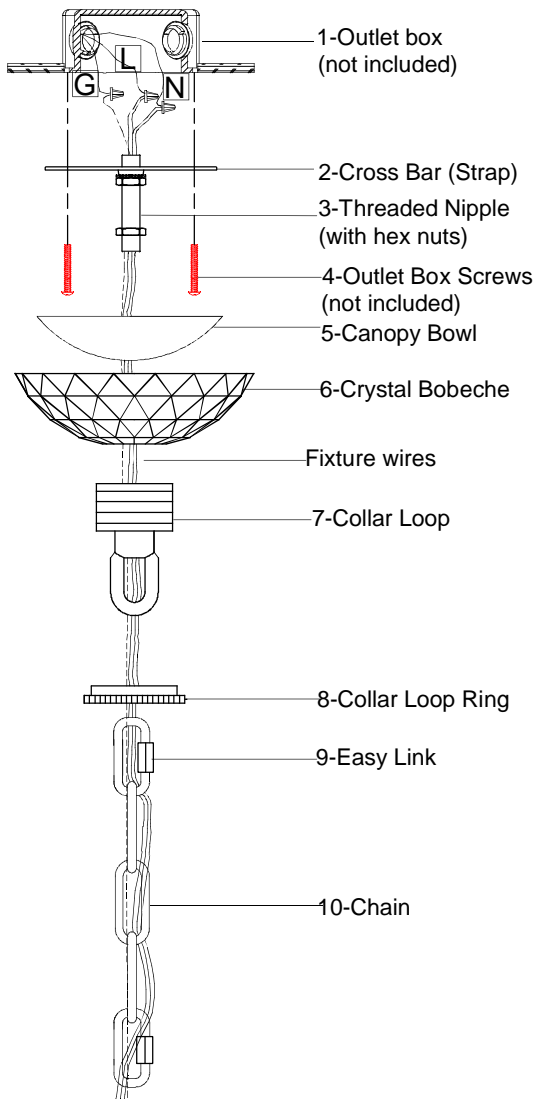

All electrical components must be installed by a licensed electrician in accordance with the National Electric code and the appropriate local electrical codes.

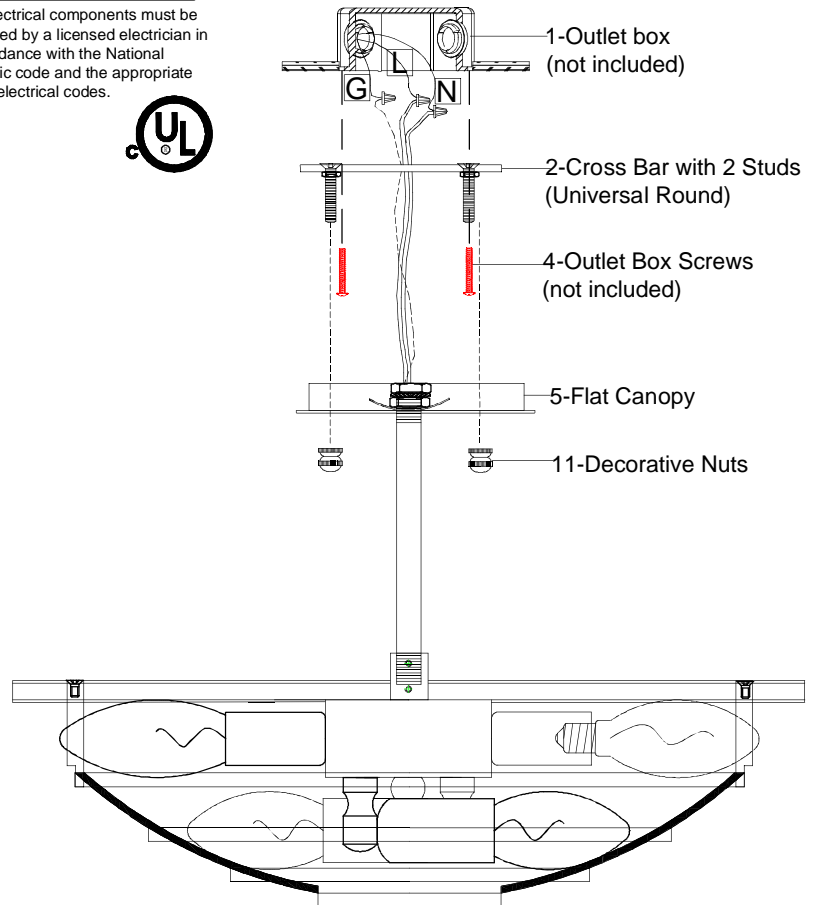

PENDANT CANOPY INSTALLATION:

Step 1. Carefully unpack parts and lay them down on a clean soft cloth for identification:

Step 2. Install Cross bar 2 to outlet box 1 with the two outlet box original screws 4

Step 3. Install Threaded Nipple 3 to Cross Bar 2 and Collar loop 7 on the other side, thighteen all parts with hex nuts to prevent from turning

Step 4. Install Canopy bowl 5 and crystal bobèche 6 to Nipple 3 then secure all parts with Collar Loop Ring 8

Step 15. Determine chain length needed for installation, if needed cut chain with a Bolt Cutter Tool. Hung chain 10 to Collar loop 7 with an easy link 9

Step 6. Assemble frame as shown in page 4 OPTION 1 (PENDANT)

SEMI-FLUSH CANOPY INSTALLATION:

Step 1. Carefully unpack parts and lay them down on a clean soft cloth for identification:

Step 2. Install Cross bar 2 with the two Studs pointing towards the floor to outlet box 1 with the two outlet box original screws 4

Step 3. Assemble frame and canopy as shown in page 4 OPTION 2 (SEMIFLUSH)

ALLEGRI

BY KALCO LIGHTING

FRAME ASSEMBLY INSTRUCTIONS

MODEL 021040

OPTION-1 (PENDANT)

Step 1. Carefully unpack parts and lay them down on a clean soft cloth for identification:

Step 2. Screw Center Stem 13 into connector 14

Step 3. Screw Loop 12 on top of center stem 13

Step 4. Hung fixture to chain 10 using the easy link 9 and Lace wires through every 3-4 chain links all the way up. Release canopy by unscrewing collar loop ring and pass wires through Nipple 3.

Step 5. Make wire connections as follows: This fixture comes with a parallel wire, split wire and connect fixture ribbed wire to power supply black wire, connect fixture smooth wire to power supply white wire, connect fixture bare copper or silver wire to power supply green wire. Secure all connections with black tape and wire nuts or as required by your local electric code.

Step 6. Raise canopy and crystal bobèche flat to ceiling and secure them with collar loop ring

Step 7. Install crystal set as shown in page 5

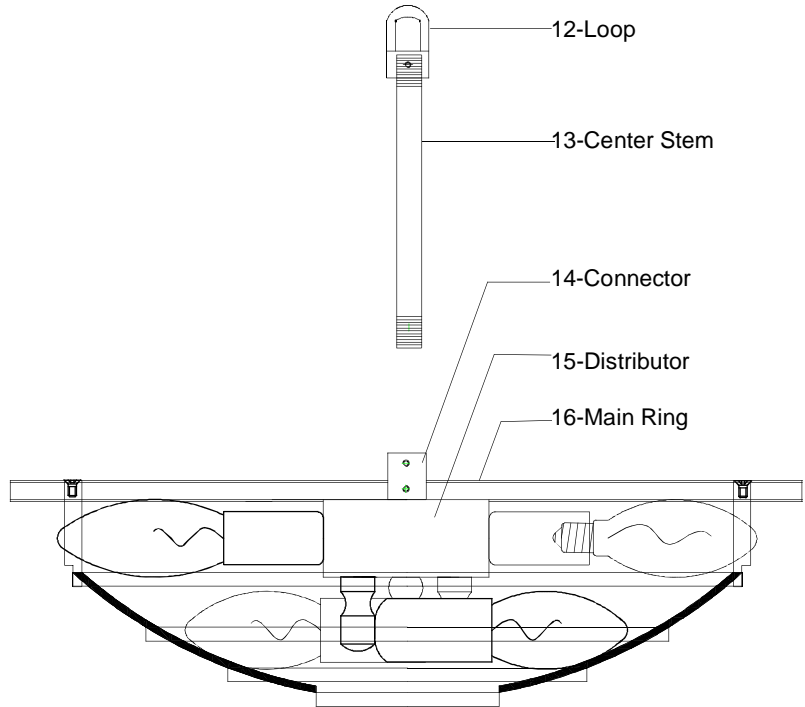

OPTION-2 (SEMI-FLUSH)

Step 1. Carefully unpack parts and lay them down on a clean soft cloth for identification:

Step 2. Screw Center Stem 13 into connector 14

Step 3. Pass Stem 13 through Canopy 5 and Washer 19 and install two Hex Nuts 17 and Lock Ring 18 on top of stem, tighten Hex Nuts to prevent fixture from turning

Step 3. Raise frame with canopy a few inches close to ceiling and make wire connections as follows: This fixture comes with parallel wire, split wire and connect fixture ribbed wire to power supply black wire, connect fixture smooth wire to power supply white wire, connect fixture bare copper or silver wire to power supply green wire. Secure all connections with black tape and wire nuts or as required by your local electric code.

Step 4. Align canopy holes with cross bar studs, push canopy flat to ceiling and secure with decorative nuts 11

Step 5. Install light bulbs (candelabra Krypton 40 watt bulbs are recommended)

Step 6. Install crystals as shown in page 5.

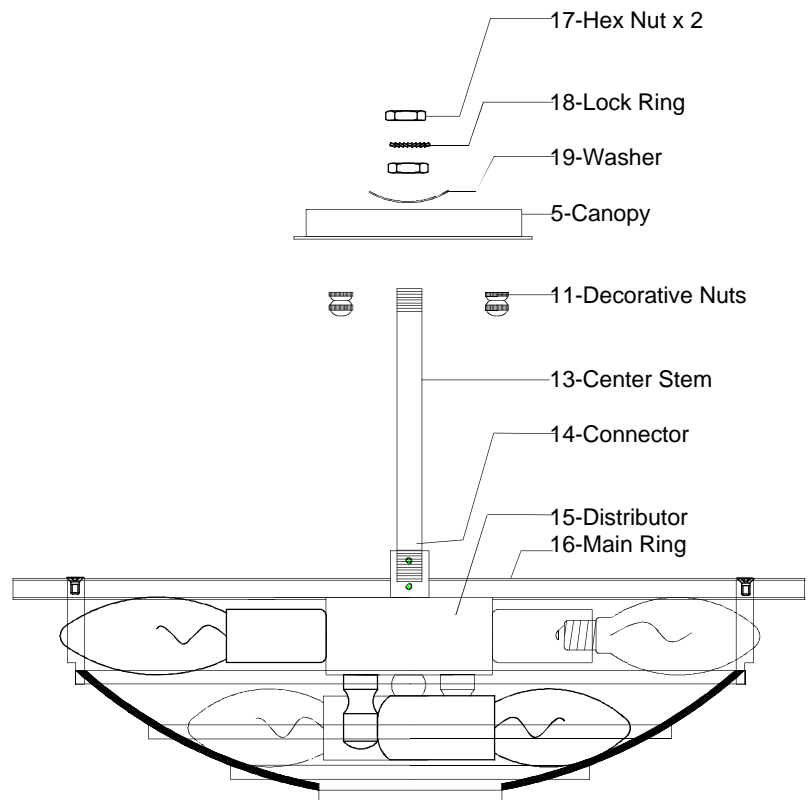

ALLEGRI

BY KALCO LIGHTING

CRYSTAL DRESSING INSTRUCTION

MODEL 021040-010-FR001

Step 1. Carefully unpack crystal parts and lay them down on a clean soft cloth for identification, wash your hands and use inspection gloves to handle crystals to avoid leaving finger print marks.

Step 2. Install Crystals (C1) and (C2) to main ring as shown in fig1 diagram below

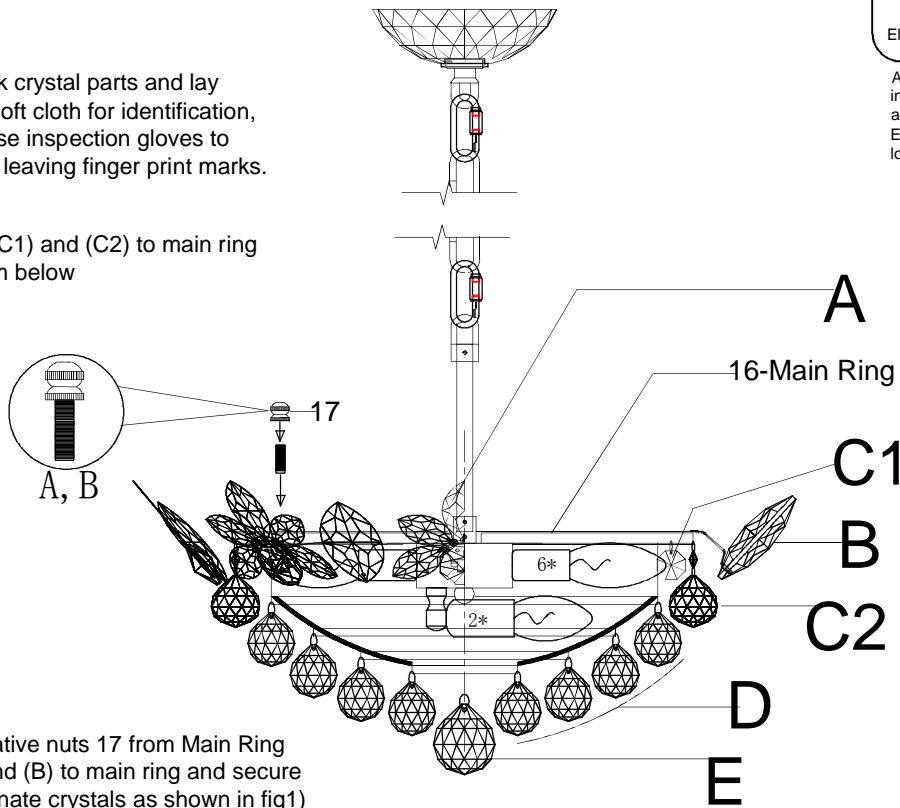

Step 3. Unscrew Decorative nuts 17 from Main Ring 16, install crystals (A) and (B) to main ring and secure them with nuts 17 (Alternate crystals as shown in fig1)

Step 4. Install 1 crystal (E) to bottom center of distributor 15

Step 5. Install 59 crystals (D) to bottom rings

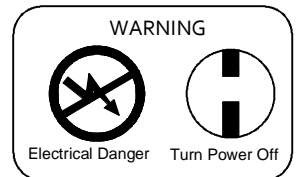

All electrical components must be installed by a licensed electrician in accordance with the National Electric code and the appropriate local electrical codes.

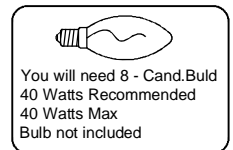

Code	Qty
A	8
B	8
C1	26
C2	26
D	59
E	1

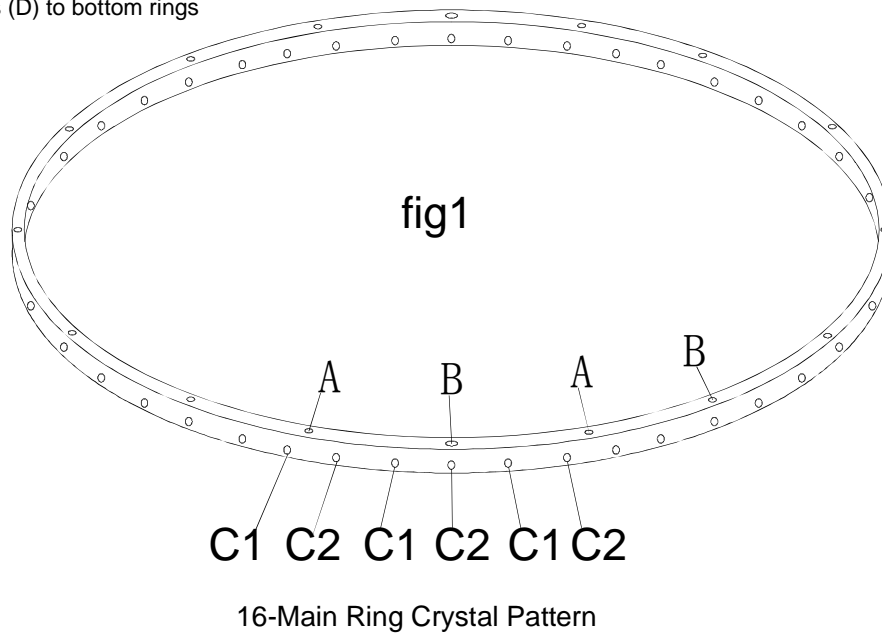

ALLEGRI

BY KALCO LIGHTING

CRYSTAL DRESSING INSTRUCTION

MODEL 021040-010-FR001

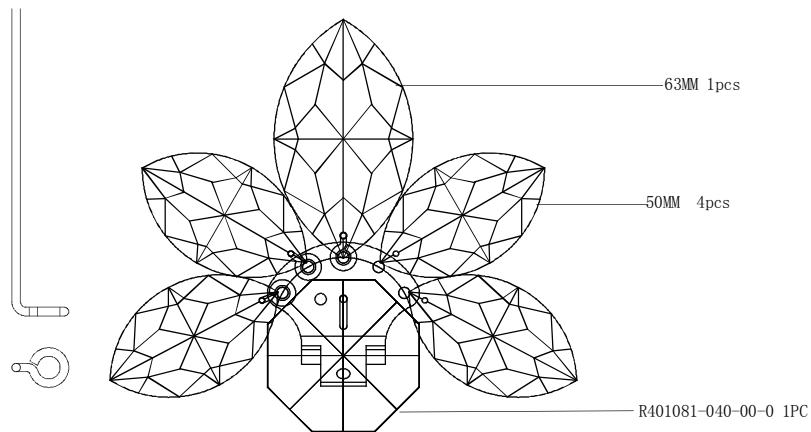

A

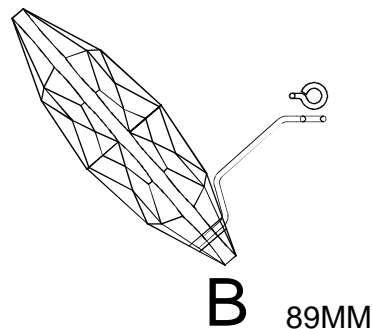

B

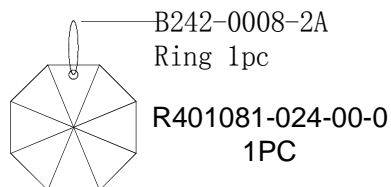

C1

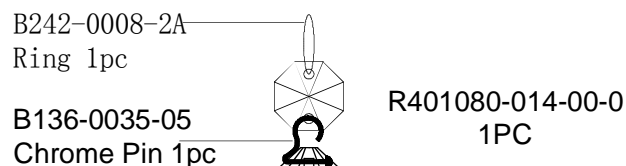

C2

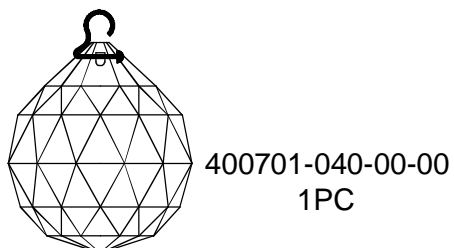

D

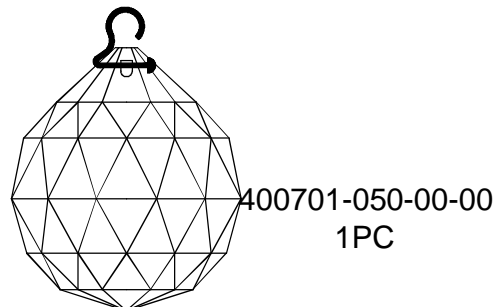

E

ALLEGRI



BY KALCO LIGHTING

LIGHTING CARE INFORMATION

Every ALLEGRI® fixture is of heirloom quality and will last for generations. To ensure it retains its brilliance and splendor for years to come, proper care and regular cleaning are necessary.

It is recommended that ALLEGRI® fixture, and particularly their crystal trim, be lightly dusted with a feather or lambs wool duster, or soft brush every two months, or whenever it appears dull or dusty. A thorough cleaning should be completed every six months.

Before cleaning an ALLEGRI® fixture, first locate the fixture's trim diagram. This will assist in replacing the crystal trim in its proper location after cleaning. Should a replacement trim diagram be required, please call 866-820-2665 to speak with an ALLEGRI® customer service representative, who can provide a new diagram.

ALLEGRI® recommends several different cleaning methods, depending on the type of fixture. Some fixtures can be cleaned with limited removal of crystal, while others must be completely untrimmed.

Place a soft towel or blanket directly beneath the fixture to limit the damage to both the crystal and the surface below the fixture, should a piece of crystal be dislodged during the cleaning process. Extreme care must be taken around any electrical fixture. For personal safety and the safety of the fixture, be sure that the fixture has been turned off. Never rotate or spin the fixture as this can cause the fixture to lose support and fall. Instead, move around the fixture while cleaning.

White Glove Method

Prepare a cleaning solution of one part isopropyl alcohol to three parts distilled water and place in a clean spray bottle.

Do not use packaged cleaning fluids, as many of these contain ammonia, which may degrade the finish of the fixture and the quality of the crystal.

Wearing white cotton gloves, spray one glove with the solution and keep one dry. Gently polish each crystal with the damp glove and immediately wipe it with the dry glove. Do not tug or pull on the crystal, as this may cause the connectors to chip or crack the crystal, or dislodge it from the fixture.

Warning: To reduce the risk of personal injury due to fire and/or electric shock, never spray solution at or near the fixture.

Crystal Removal Method

Gently remove trim and hand-wash the crystal in lukewarm water using a mild detergent. Rinse in clean water and dry with a soft clean cloth. Do not soak finished crystal such as SWAROVSKI ELEMENTS Colors: Teak, Golden Shadow or Silver Shade, for extended periods, as this may degrade the crystal's finish.

With the fixture untrimmed and turned off, wipe the frame, including the light bulbs once they are completely cool, with a soft cloth.

Wearing white gloves, finger-cots or using a soft clean cloth, gently replace the trim as directed in the trim diagram.